

CARATTERISTICHE COSTRUTTIVE / CONSTRUCTION FEATURES
CARACTERÍSTICAS CONSTRUCTIVAS / CARACTÉRISTIQUES D'EXÉCUTION

Corpo pompa	ghisa
Pump body	cast iron
Cuerpo bomba	fundición
Corps de pompe	fonte
Supporto motore	ghisa
Motor bracket	cast iron
Soporte motor	fundición
Support moteur	fonte
Girante	ghisa / ottone (CSB)
Impeller	cast iron / brass (CSB)
Rodete	fundición / latón (CSB)
Turbine	fonte / laiton (CSB)
Tenuta meccanica	ceramica-grafite
Mechanical seal	ceramic-graphite
Sello mecánico	cerámica-grafito
Garniture mécanique	céramique-graphite
Albero motore	acciaio AISI 303 acciaio AISI 416 (CS 75±100)
Motor shaft	stainless steel AISI 303 stainless steel AISI 416 (CS 75±100)
Eje motor	acero AISI 303 acero AISI 416 (CS 75±100)
Arbre moteur	acier AISI 303 acier AISI 416 (CS 75±100)
Temperatura del liquido	
Liquid temperature	0 - 90 °C
Temperatura del liquido	
Température du liquide	
Pressione di esercizio	
Operating pressure	max 6 bar
Presión de trabajo	
Pression de fonctionnement	
MOTORE / MOTOR / MOTOR / MOTEUR	
Motore 2 poli a induzione	3~ 230/400V-50Hz
2 pole induction motor	1~ 230V-50Hz (con termoprotettore with thermal protection)
Motor de 2 polos a inducción	(con termoprotettore with thermal protection con protección térmica avec protection thermique)
Moteur à induction à 2 pôles	
Classe di isolamento	
Insulation class	F
Clase de aislamiento	
Classe d'isolation	
Grado di protezione	
Protection degree	IP44
Grado de protección	
Protection	



Pompe centrifughe monogiranti da scorrimento a media e alta portata caratterizzate da bocche di mandata da 2", 3" e 4"; trovano primaria applicazione nel campo dell'agricoltura e in tutte le applicazioni in cui una consistente portata è richiesta.

Single impeller centrifugal pumps, medium head high flow rate with 2", 3" and 4" delivery openings; mainly used in agriculture and applications requiring high level delivery.

Bombas centrífugas con un rodete de desplazamiento de caudal medio y alto caracterizadas por bocas de salida de 2", 3" y 4"; encuentran aplicación primaria en el campo de la agricultura y en todas las aplicaciones en las que se solicita un caudal consistente.

Pompes de circulation centrifuges monoroue à débit moyen et élevé, caractérisées par des brides de refoulement de 2", 3" et 4"; elles trouvent leur application principale en agriculture et dans toutes les applications qui nécessitent un débit élevé.

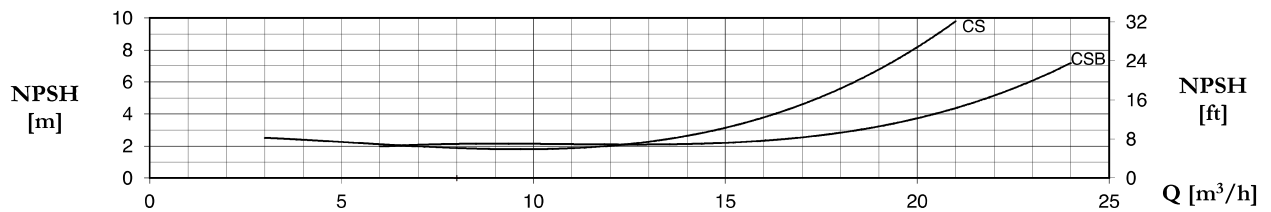
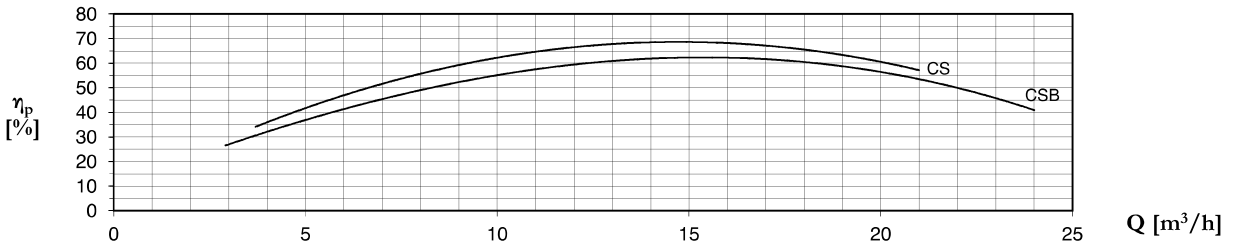
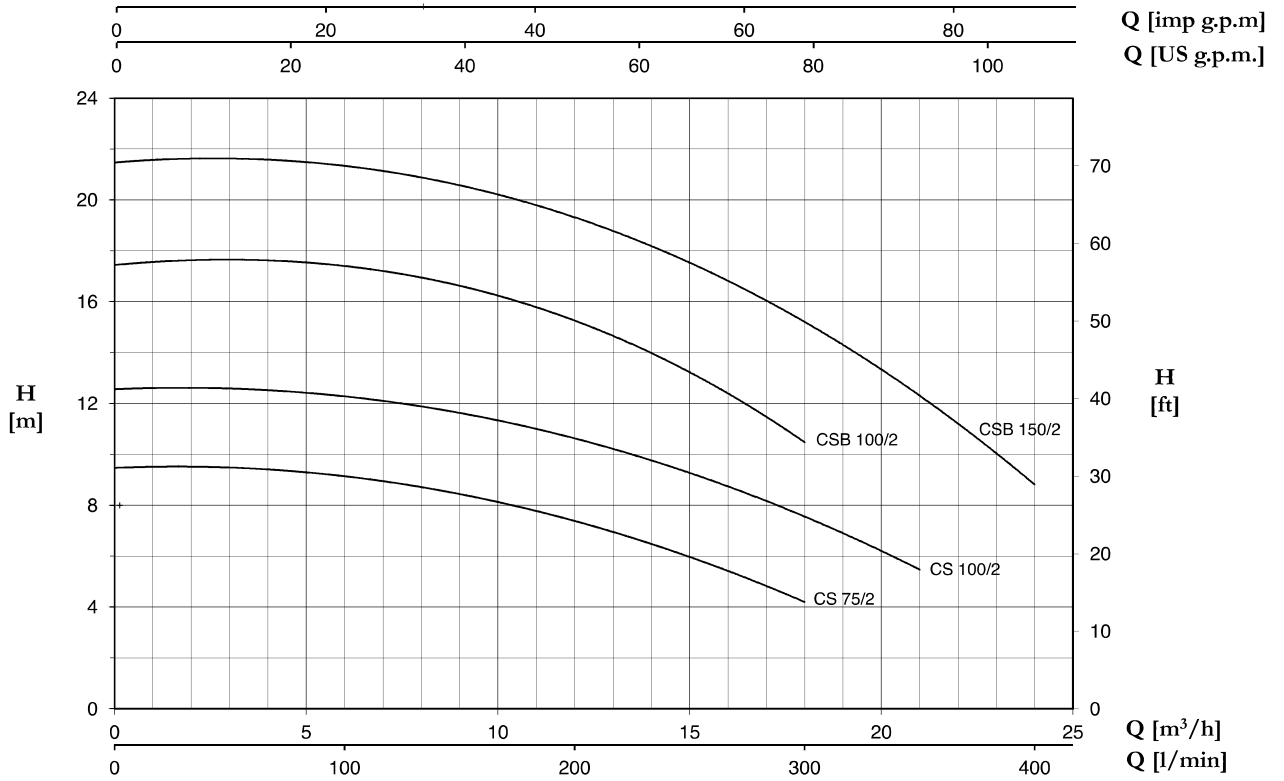

TYPE		P2		P1 (kW)		AMPERE		Q (m³/h - l/min)								
1~	3~					1~	3~	0	3	6	9	12	15	18	21	24
								0	50	100	150	200	250	300	350	400
		(HP)	(kW)	1~	3~	1x230 V 50 Hz	3x400 V 50 Hz	H (m)								
CS 75/2	CST 75/2	0,8	0,59	0,63	0,7	2,9	1,3	9,5	9,4	9,2	8,5	7,3	6	4,2	-	-
CS 100/2	CST 100/2	1	0,74	0,92	1,05	4,3	2,3	12,6	12,5	12,3	11,7	10,6	9,3	7,5	5,5	-
CSB 100/2	-	1	0,74	1,23	-	6	-	17,5	17,5	17,5	16,7	15,2	13,2	10,5	-	-
CSB 150/2	CSBT 150/2	1,5	1,1	1,78	1,65	8,5	3	21,5	21,5	21,5	20,6	19,2	17,5	15,3	12,3	8,8

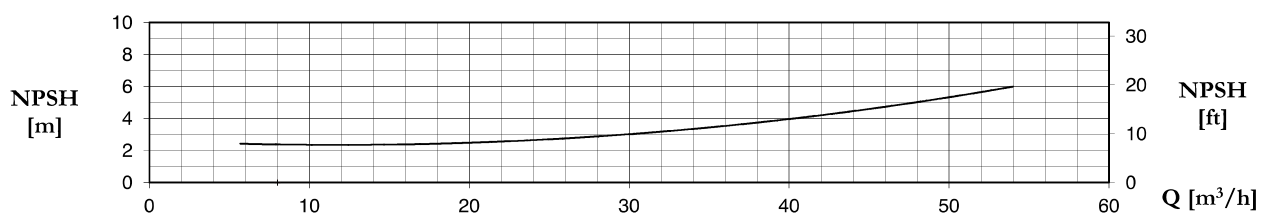
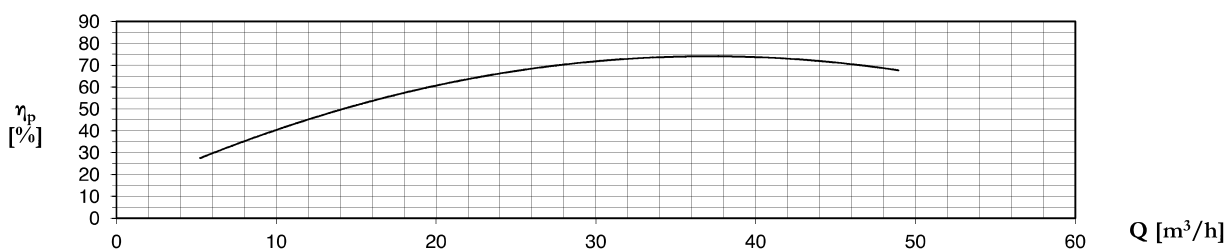
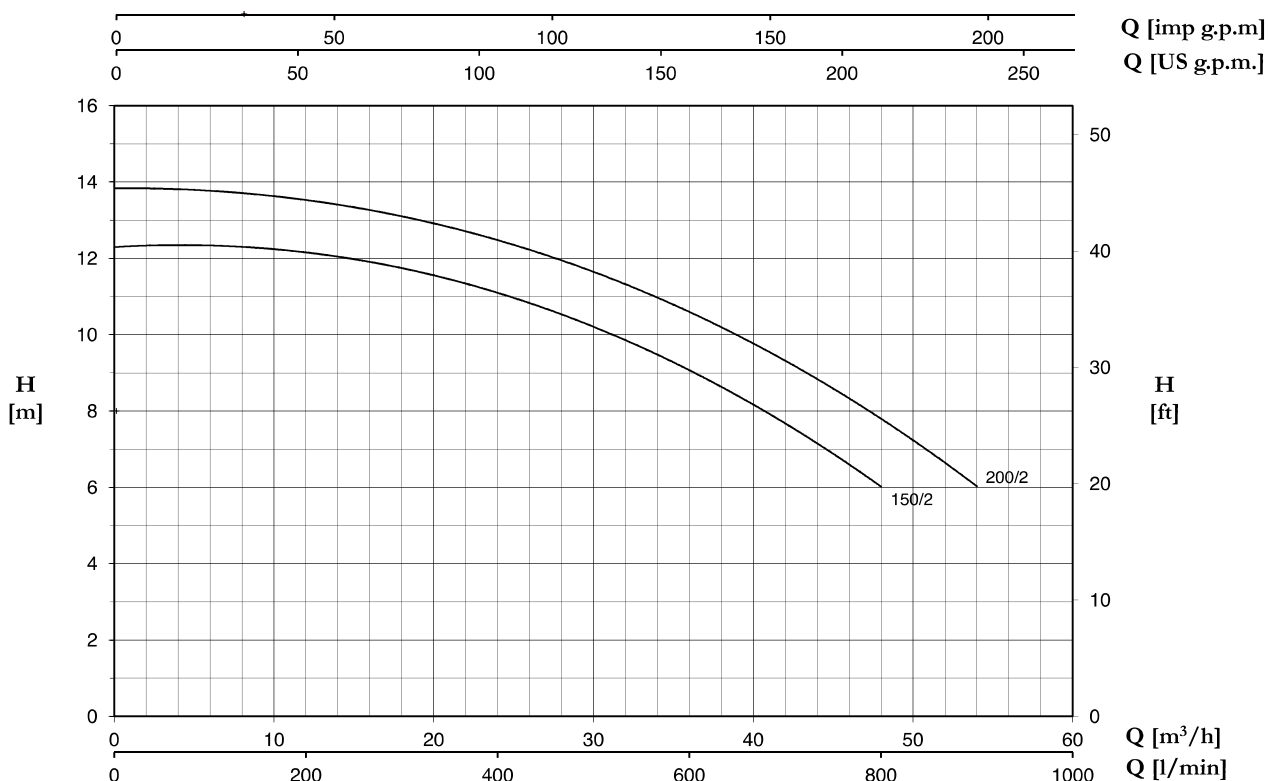

TYPE		P2		P1 (kW)		AMPERE		Q (m ³ /h - l/min)									
1~	3~					1~	3~	1~	3~	0	6	12	18	24	30	36	42
		0	100	200	300					400	500	600	700	800	900		
								H (m)									
CS 150/2	CST 150/2	1,5	1,1	1,85	1,8	8,8	3,3	12,3	12,3	12,2	11,8	11,0	10,2	9,1	7,7	6	-
CS 200/2	CST 200/2	2	1,5	2,1	2,1	10	3,9	13,8	13,8	13,6	13,1	12,4	11,6	10,6	9,4	7,8	6

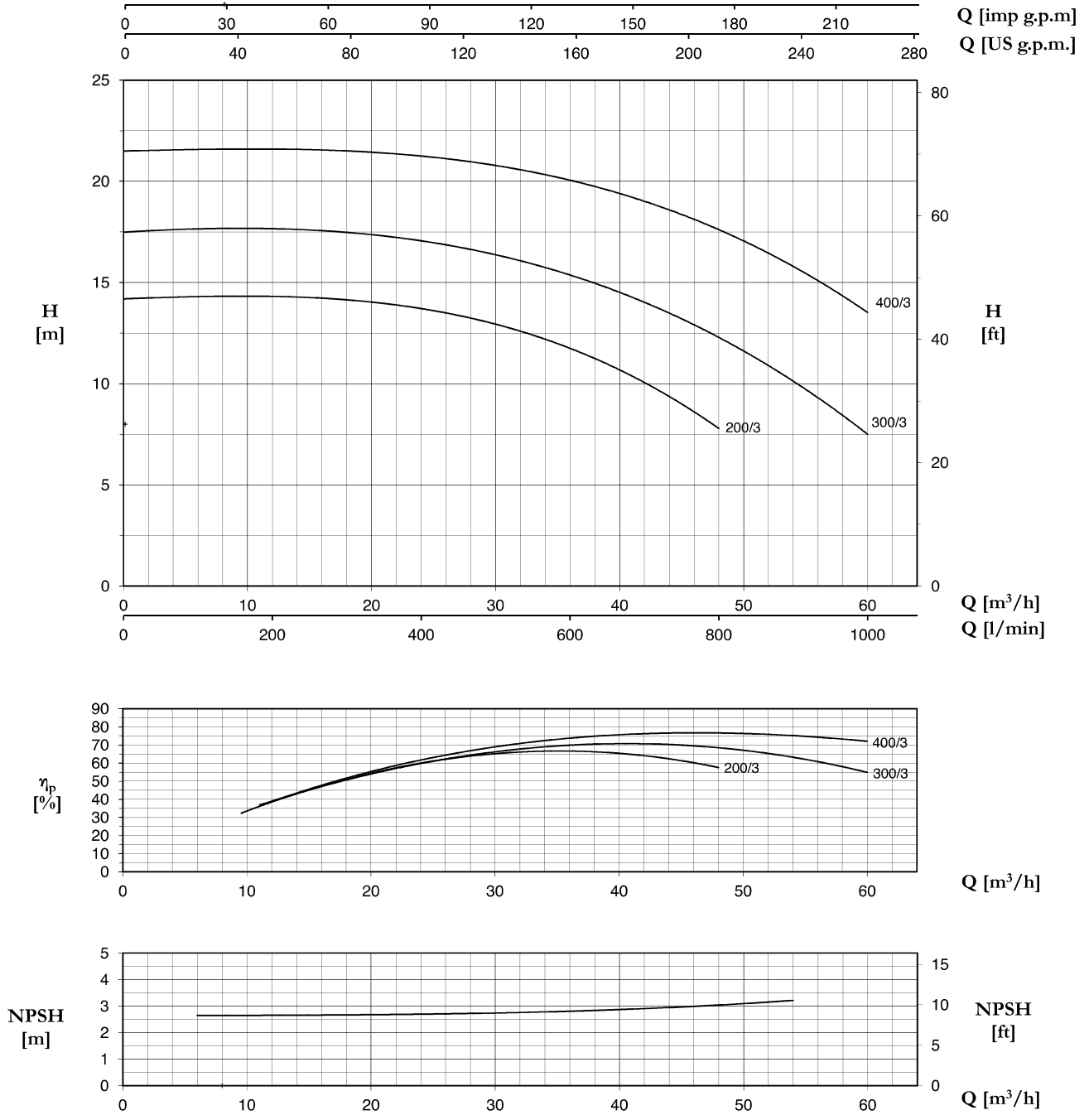

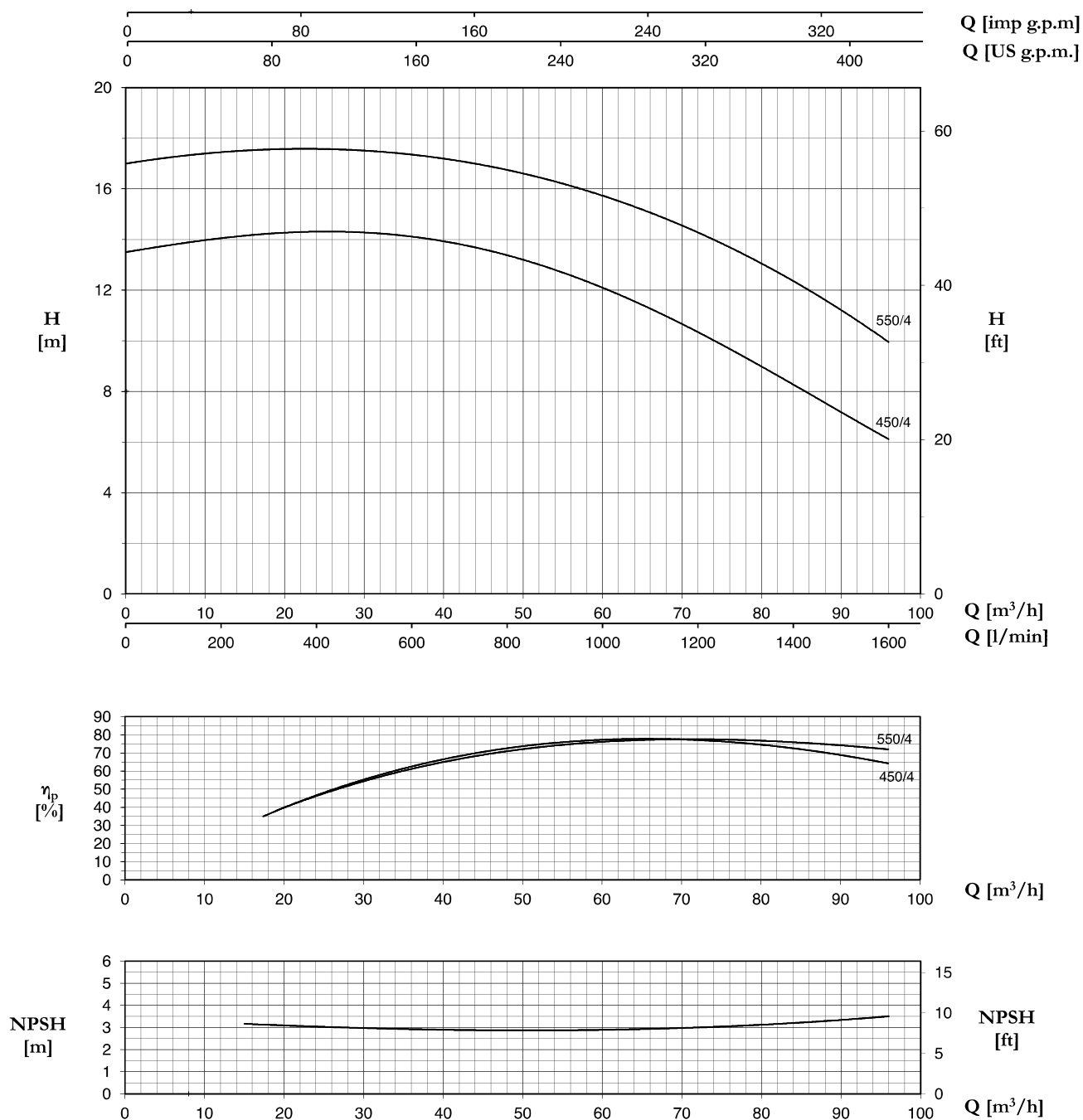

TYPE		P2		P1 (kW)		AMPERE		Q (m³/h - l/min)					
1~	3~					1~	3~	0	15	24	36	48	60
						1x230 V 50 Hz	3x400 V 50 Hz	H (m)					
		(HP)	(kW)	1~	3~								
CS 200/3	CST 200/3	2	1,5	2,35	2,15	11	3,6	14,2	14,2	13,8	11,7	7,8	-
CS 300/3	CST 300/3	3	2,2	3,3	2,9	15	4,9	17,5	17,5	17,2	15,3	12,3	7,5
-	CST 400/3	4	3	-	4	-	6,7	21,5	21,5	21,4	19,9	17,7	13,5

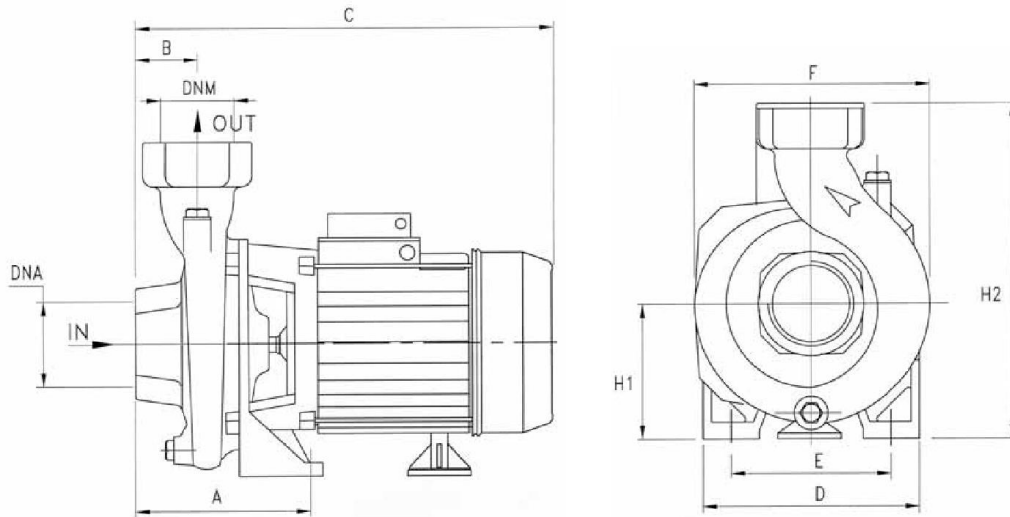

TYPE		P2		P1 (kW)		AMPERE		Q (m³/h - l/min)						
1~	3~					1~	3~	0	36	48	60	72	84	96
		0	600	800	1000			1200	1400	1600				
		(HP)	(kW)	1~	3~	1x230 V 50 Hz	3x400 V 50 Hz	H (m)						
CS 450/4	CST 450/4	4	3	3,7	3,6	18	6,2	13,5	14,1	13,4	12,1	10,3	8,3	6,1
-	CST 550/4	5,5	4	-	5,05	-	8,8	17	17,3	16,8	15,7	14,4	12,2	10,0



TYPE	DIMENSIONS (mm)													
	A	B	C	D	E	F	H1	H2	DNA	DNM	I	L		M
CS 75/2	127	45	315	155	115	178	97	247	2" G	2" G	340	195	280	14.2
CS 100/2	127	45	315	155	115	178	97	247	2" G	2" G	340	195	280	15.5
CS 150/2	150	53	370	180	140	218	115	285	2" G	2" G	390	230	325	23.3
CS 200/2	150	53	370	180	140	218	115	285	2" G	2" G	390	230	325	24.3
CSB 100/2	130	70	365	180	130	195	90	240	2" G	2" G	390	230	325	18.2
CSB 150/2	130	70	365	180	130	195	90	240	2" G	2" G	390	230	325	19.1
CS 200/3	176,5	80	455	200	140	225	112	292	3" G	3" G	480	245	330	28.3
CS 300/3	176,5	80	455	200	140	225	112	292	3" G	3" G	480	245	330	31.5
CST 400/3	176,5	80	455	200	140	225	112	292	3" G	3" G	480	245	330	31.6
CST 450/4	165	85	480	220	160	250	130	330	4" G	4" G	510	275	365	41.1
CST 550/4	165	85	480	220	160	250	130	330	4" G	4" G	510	275	365	41.1

TYPE				
	TRUCK		CONTAINER	
	PALLET (cm)	N° pumps	PALLET (cm)	N° pumps
CS 75/2-100/2	90x110x145	65	90x110x195	91
CS 150/2-200/2	85x110x140	40	85x110x205	60
CS 200/3-300/3	85x110x150	30	85x110x180	60
CS 450/4-550/4	80x120x150	30	80x120x180	60